

# OPERATIONS MANAGER 1300

## QUICK START GUIDE

Includes: OM1300 Family of Operations Managers

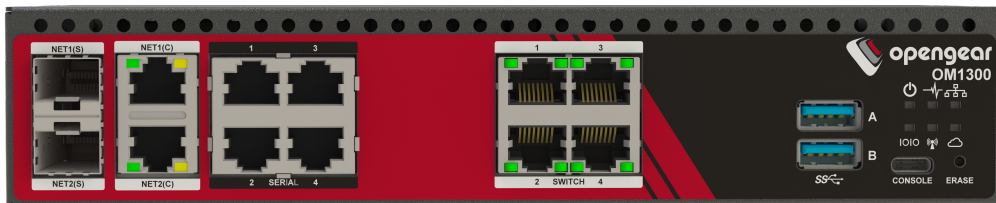

## REGISTER

This Quick Start Guide covers basic installation and configuration of the OM1300.

For detailed:

- guidance, consult the Operations Manager User Guide:  
<https://opengear.com/support/documentation/>.
- information about the variants available for this model, see the product selector:  
<https://opengear.com/product-selector/>.

Register your product at: <https://portal.opengear.com/s/>.

When you register, you will:

- activate your warranty.
- be notified when firmware updates are released: <https://opengear.com/support/device-updates/>.

# WHAT'S IN THE BOX

## OM1300 Device



**1.6GHz Quad-Core Cortex-A53 Arch64 ARMv8**  
4GB LPDDR4 Memory, 32GB Storage



**API Based Firmware**  
Supports Python, Docker



**Embedded TPM 2.0**  
HW Level Security

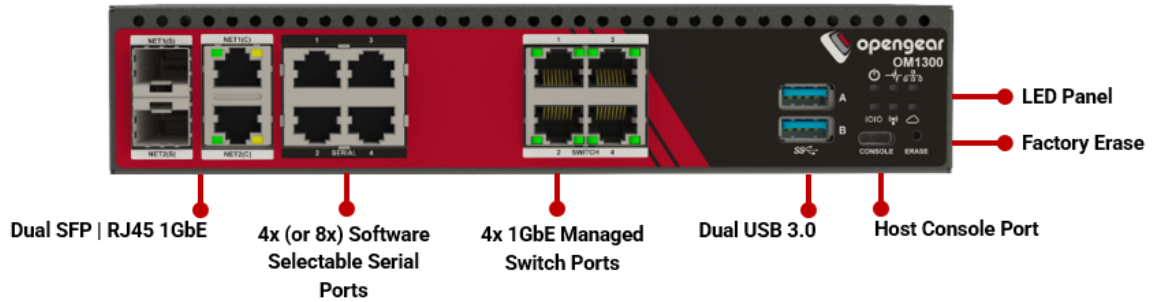

## OM1300 - Cellular model

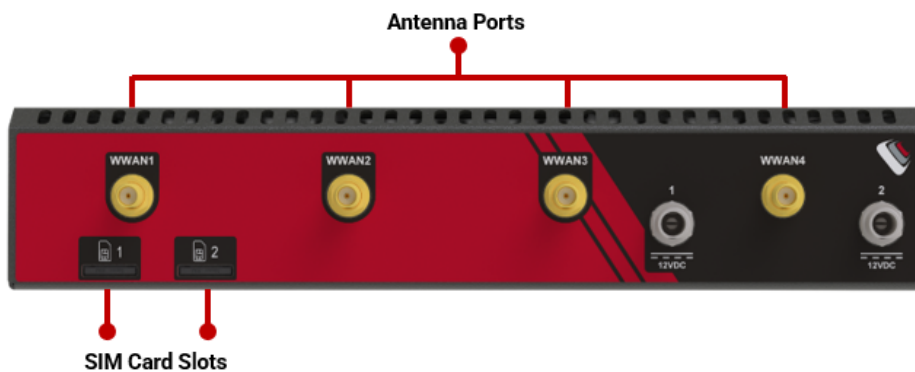

## Kit Contents



### Notes:

- Contents may be different from those pictured due to region or supplier.
- The power cord is useable only with the device. Do not use it for any other purpose.

Label	Item	Quantity	Notes
	OM1300 device	1	
1	Rack Mount Kit	1	Part number 590054
2	C14 Power Cable	1	Part number 440055
3	A/C Power Brick	1	Part number 450047
4	Cellular Antennas - cellular models only	4	Part number 569052

# HARDWARE INSTALLATION

## Step 1. Connect Network Interfaces

Connect the device to a local network using any of the available physical network interfaces. All interfaces will receive a dynamic address via DHCP and DHCPv6.

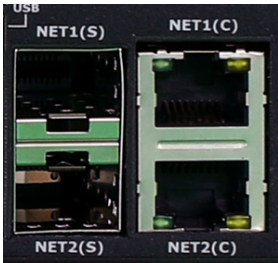

**Figure:** Network interfaces for 1Gb Ethernet models

Additionally, the device can be accessed from a computer or local network via interface NET1 or NET2 with a static IPv4 address as shown in [Table: Default static interface connection](#).

Model	Interface	Static Address
1Gb Ethernet	NET1	192.168.0.1/24
1Gb Ethernet	NET2	192.168.0.1/24

**Table:** Default static interface connection

Firewall Zone	Network Interfaces
WAN	NET1
LAN	NET2

**Table:** Default firewall zones for interfaces

## Step 2. Connect Serial Devices

Connect managed devices to the serial interfaces on the front of the unit.

## Step 3. Connect Cellular Antennas

For -C models, attach the included antennas to the antenna ports.

## Step 4. Install SIM Card(s)

Two SIM card slots are located on the rear face of the device between the antennas. Place each SIM card into the supplied SIM card tray, then insert the tray into its respective slot (marked 1 and 2) until you feel it click into place.

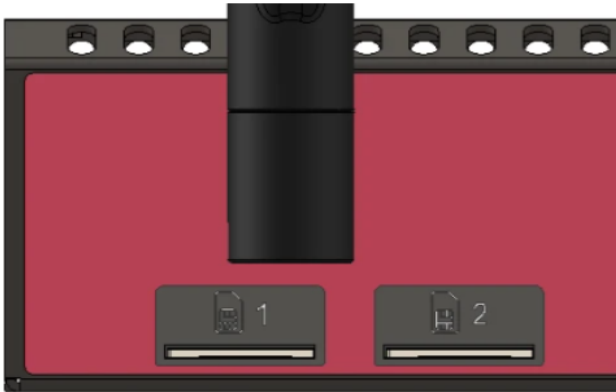

See the Appliance Software User Guide for cellular connection status LED states.

## Step 5. Connect USB Devices

USB serial devices can be connected to the USB 3.0 slots at the front of the unit if required.

## Step 6. Connect The Power

Connect the power cable to the rear of the unit.

On dual power supply units a second power cable can be connected if redundancy is required. The power cables can be connected in any order.

### LED Power Status Indicator



**Figure:** Power supply has redundancy

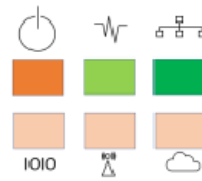

**Figure:** Power supply does not have redundancy

**Note:** On devices with a single power supply, the LED power status indicator will be green at all times.

# ACCESS THE DEVICE

## Step 1. Log in via the Web UI

Using a computer on the same subnet as the static network interface shown in "Hardware Installation" on page 1, access the web UI with your web browser at <https://192.168.0.1/>.

**Note:** The device has a self-signed SSL certificate. Your browser will display an "Untrusted connection" warning. Click through the warning to access the login page.

To log in for the first time, enter the username **root** and password **default** and click **Submit**.

**Note:** The factory default password automatically expires after a factory reset and users must choose a new password. This policy is applied through the WebUI, Config Shell, and CLI.

## Step 2. Change the Root Password

When logging in to the device for the first time you will be prompted to change the root password immediately.

The following password complexity settings are selected by default for factory reset devices and upgrades:

- Minimum password length of eight characters.
- Passwords must contain an uppercase letter.
- Passwords must contain a numeric character.
- Disallow usernames in passwords.

**Note:** Users are prevented from using the word "default" as their password.

Enter the current password followed by the new password and click **Log in**.

The **ACCESS > Serial Ports** page appears displaying a list of connected serial devices and links to a Web Terminal or SSH connection for each.

## CONFIGURE SERIAL PORTS

To change settings for individual serial ports:

1. Navigate to **CONFIGURE > Serial Ports**.
2. Click the **Edit** button  next to the port you want to modify.
3. Change port settings, logging settings or configure IP aliases.
4. Click **Apply** to save changes.



Field	Value
Mode	ConsoleServer
Pinout	X2
Data Bits	8
Parity	None
Stop Bits	1

**Table:** Default configuration for serial ports

## CONFIGURE LOCAL CONSOLE

Operations Manager OM1300 units have:

- one RJ45 serial console.
- one dedicated USB-C serial console for local management

LOCAL MANAGEMENT CONSOLES		
Management Console	Parameters	Actions
USB-C Serial Console	9600-8N1 VT102	 



To configure local console ports:

1. Navigate to **CONFIGURE > Serial Ports**.
2. Click the **Edit** button next to the serial port you want to modify.
3. Change port settings.
4. Click **Apply** to save changes.

## CONFIGURE NETWORK

[CONFIGURE](#) > [Network Connections](#) > [Network Interfaces](#)

Click to expand any row to display status information about the interface and its connections.

NETWORK INTERFACES			
 NET1 - 1G Copper/SFP	2 IPv4 connections 1 Automatic 1 Static	1 IPv6 connections 1 Automatic 0 Static	▼
 NET2 - 1G Copper/SFP	1 IPv4 connections 1 Automatic 0 Static	1 IPv6 connections 1 Automatic 0 Static	▼

## CONFIGURE PHYSICAL INTERFACES

On the Network Interfaces page, click the drop-down arrow on the right side of the target network interface then, click the **Edit** button  to configure media and MTU for any of the physical interfaces.

 **NET1 - 1G Copper/SFP**

Enabled

Disabled

 Enabled Automatic

## Modify Default IPv4 Static Interface

1. Click the **"IPv4 Static"** label under NET1 (1G) to open the edit connection page.
2. Enter the IPv4 address.
3. Enter the network mask.
4. Click **Apply** to save changes.

## View Switch Port Interfaces

OM1300 models have an integrated Ethernet switch. The switch ports are bridged together by default in the interface called "Switch".

**Switch**

8 Bridged Interfaces

0 IPv4 connections  
0 Automatic 0 Static

0 IPv6 connections  
0 Automatic 0 Static

Enabled

Disabled

Edit 
Delete

**Bridged Interfaces**

- Switch Port 1
- Switch Port 2
- Switch Port 3
- Switch Port 4
- Switch Port 5
- Switch Port 6
- Switch Port 7
- Switch Port 8

There are currently no connections. [Add a new connection](#)

This default bridge can be modified or deleted to configure custom bridges or bonds between any interface.

For more details, consult the Operations Manager User Guide:

<https://opengear.com/support/documentation/>.

## CREATE NEW ADMINISTRATIVE USER

**Note:** You should create a new administrative user rather than continuing as the root user.

1. Navigate to **CONFIGURE > User Management > Local Users**.
2. Click the **Add User** button  at the top-right of the page.
3. Click the **User Enabled** checkbox.
4. Enter **Username** and **Password**.
5. Assign the **admin** group to the user to provide full access privileges.
6. Click **Save User** to create the new user account.
7. Log out and log back in as this user for all administrative functions.

### Group Memberships

<input type="checkbox"/>	Group Name	Description
<input checked="" type="checkbox"/>	admin	Provides users with unlimited configuration and management privileges
<input type="checkbox"/>	netgrp	Group for users created automatically via network authentication

1 / 2 Groups Selected

For more details about Users and Groups configuration, consult the Appliance Software User Guide:

<https://opengear.com/support/documentation/>.

## ACCESS DEVICE CONSOLES

After you have attached managed devices and configured serial ports by following "[Configure Serial Ports](#)" on page 8, you can now access the console of your managed devices on your network.

### Web UI

1. Navigate to **ACCESS > Serial Ports** to view the list of serial ports on the device.
2. Click the **Web Terminal** button  to the right of any serial port in Console Server mode to access it via the web terminal.

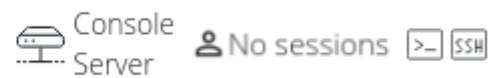

### Console

For administrator users logged in to the device via console or SSH:

1. Type *pmshell* to view the list of available managed devices.
2. Enter the **port number** to access the desired device and press **Enter**.

### SSH

The managed devices connected to the Operations Manager can be accessed directly with an SSH command to connect to the device.

- To view the list of managed devices: `ssh <username>+serial@<device address>`
- To connect to a specific device by port: `ssh <username>+port<number>@<device address>`
- To connect to a specific device by name: `ssh <username>+<port label>@<device address>`

**Note:** The SSH delimiter can be modified via the Web UI at **CONFIGURE > Services > SSH**.

### Telnet

Telnet access to managed devices is not supported at this time.

## LIGHTHOUSE CENTRALIZED MANAGEMENT

**Note:** Lighthouse is a powerful tool that simplifies the way you manage your out-of-band network through a single pane of glass. Better control and visibility provides 24/7 resilient access to your connected IT infrastructure. For more information, visit <https://opengear.com/products/lighthouse/>.

To enroll your device:

1. Navigate to **CONFIGURE > Lighthouse Enrollment**.
2. Click the **Add Lighthouse Enrollment** button  at the top-right of the page.
3. Enter the Lighthouse Address, Enrollment Token, optional port and optional Enrollment Bundle.
4. Click Apply to begin the enrollment process.

**Note:** Enrollment of an Opengear device can also be performed from Lighthouse using **Add Node** functionality.

### Automatic Enrollment By Lighthouse Service Portal (LSP)

Lighthouse Service Portal (LSP) is an Opengear solution that enables to perform a zero touch call home and automatic enrollment into a customers Lighthouse instance of choice.

**Note:** LSP is not configurable and cannot be added in-field.

No user setup is required for LSP. LSP should begin working upon boot or factory reset.

### LSP Service Initialisation

When the node is initially powered-up or rebooted, ZTP begins to run and sees that device is LSP enabled and ZTP exits before applying any configuration. `Systemd` triggers the LSP.

The node connects to internet and adds an NTP server to ensure crypto is working. It then pulls an updated docker container which it runs, and waits while the docker container writes out the appropriate lighthouse bundle associated with the serial number, then exits.

Identity is verified by a TPM attestation key with the serial number encoded and signed by the attestation key and a CA running in AWS. An accompanying certificate is stored the secure Trusted Platform Module (TPM).

If there are no connectivity issues the LSP status LED state changes progressively from amber flashing (lsp is running), green flashing (Lighthouse is connecting) and green solid (lighthouse connected successfully).

<p>Cloud / Internet</p> 	<p>LSP is disabled and there are no existing Lighthouse enrollments.</p>	<p>LSP is currently running on the device.</p>	<p>An error occurred while running LSP.</p>	<p>The device can reach the lighthouse instance and is attempting to enroll. If a lighthouse is unreachable the LED will not start.</p>	<p>The device is enrolled and connected to a lighthouse. There will be a short delay between the UI status reported and the LED changing to solid green.</p>
---	--	--	---	---	--